

TUCSEN

BSI sCMOS Camera



Dhyana95 V2

**Smaller,
but Mightier.**



Smaller size but more functions

Dhyana95 V2 adopts Tucsen’s new technology and performance standard. The smallest dimension among peers for scientific imaging makes it more popular for demanding compact space. The water-cooling method and CameraLink interface apply the camera for conditions requiring high stability.

	Dhyana95	Dhyana95 V2
Appearance		
Air-cooling	●	●
Water-cooling		●
USB3.0	●	●
CameraLink		●
Size (mm)	120x119x121	100x118x127



Faster readout by doubling speed

Dhyana95 V2 adds a STD high speed readout mode, of which the frame rate is up to 48fps@4.2MP which is twice as the normal mode. It can be achieved progressively by using ROI function for applications demanding special frame rate.

ROI	Normal(16-bit)	STD(12-bit)
2048 x 2048	24	48
1608 x 1608	31	61
1200 x 1200	41	81
1024 x 1024	48	95
2048 x 512	95	190
2048 x 256	189	375
2048 x 128	369	739

Superior background with accurate calibration

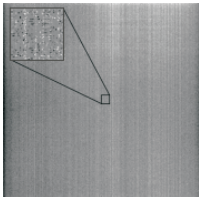
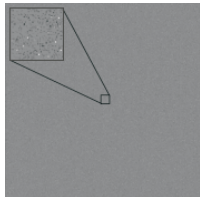
Dhyana95 V2 now can provide a superior background for quantitative analysis applications. The DSNU/PRNU have reached the international optimum of 0.2e- and 0.3% respectively, as the problems from sensor production process, such as edge glow, dead pixels as well as pixel non-uniformity, all have been calibrated accurately.

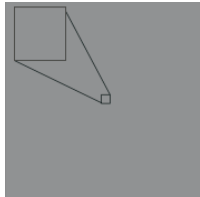
	Dhyana95	Dhyana95 V2
DSNU		
PRNU		

95% quantum efficiency, and excellent SNR

The Dhyana95 V2 uses backside-illuminated sCMOS thinned chip technology to avoid light interference from the wiring layer. It has excellent response capabilities in the ultraviolet, visible and near-infrared bands, with a peak quantum efficiency of up to 95%@560nm, and when the number of incident photons are more than 3, it can have a better SNR performance than the typical EMCCD camera of 97% peak QE.

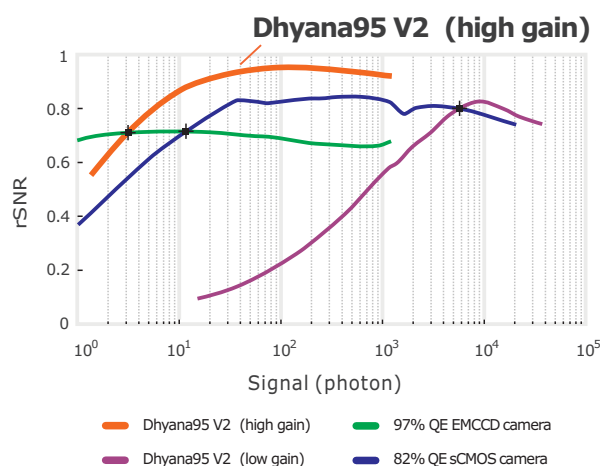
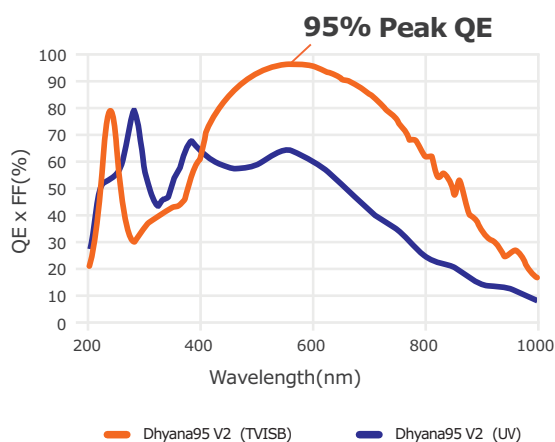

100Ke- full-well capacity, high dynamic range

Thanks to the 11um large pixel, Dhyana95V2's full-well capacity can be up to 100,000 electrons. Advanced High Dynamic (HDR) mode, through dual-channel gain combined, it can present high-quality images with rich details of dark and bright in real time, which is very useful in applications such as life science.

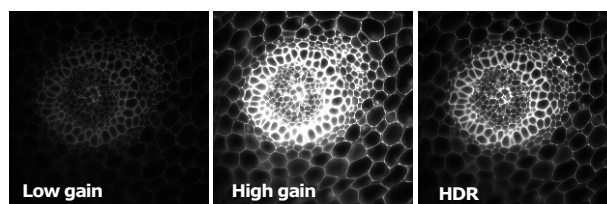

2" area, large field of view

The 2" array can not only adapt to more optical interfaces and deliver a greater field of view, but also results in fewer lens switches to find the area of interest on the sample.

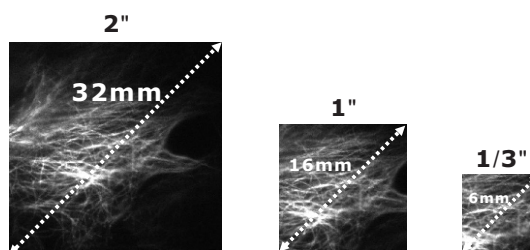

STORM Imaging

“Extensive tests and comparisons with other top-of-the-line EMCCD and sCMOS cameras have been performed in our laboratory. We found Dhyana95, the new sCMOS camera stood its own ground remarkably well and offered satisfactory performance across the board”.

—Professor Ning Fang at Georgia State University

- a. 95% QE Dhyana95
- b. 97% QE EMCCD camera
- c. 82% QE sCMOS camera

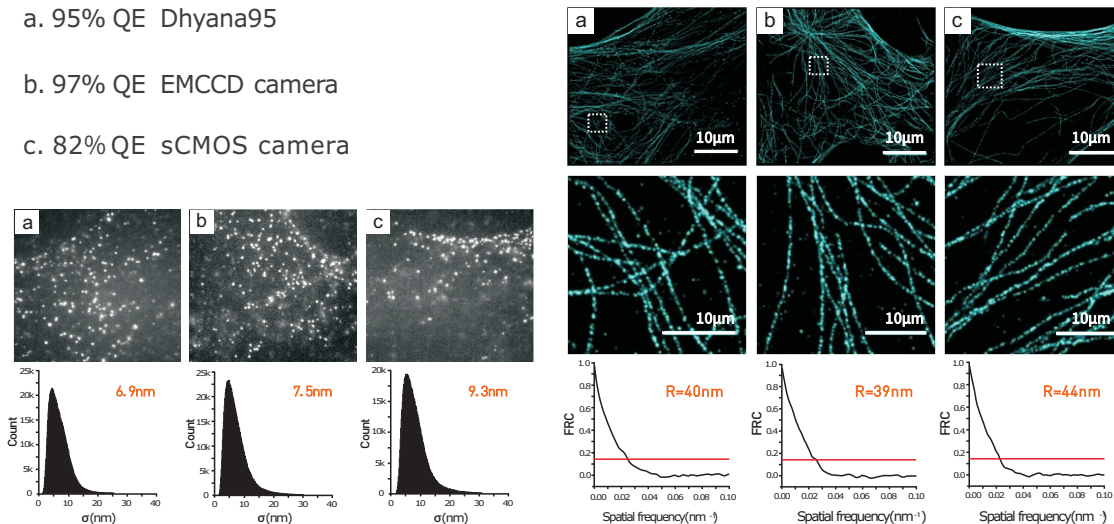

Soft X-ray Detection

The distinctive features of Dhyana95 make it an excellent alternative to back-illuminated CCDs which are commonly applied in soft X-ray applications of previous-generation synchrotrons, such as coherent scatter experiments. They would greatly benefit fully from the Dhyana95's high frame rates.

—Kewin Desjardins, from the French SOLEIL synchrotron

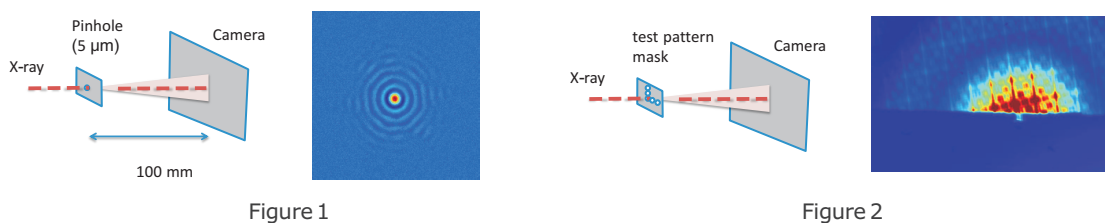
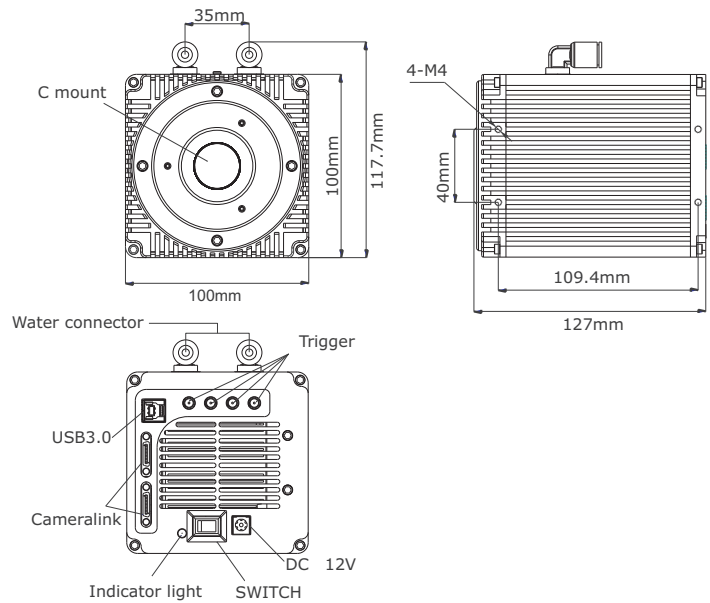

Figure 1. A 5 micron pinhole diffraction spot of 186 eV recorded by Dhyana95, which shows excellent dynamic range with its image diffraction order of the reached to the maximum value, the 6th.

Figure 2. A composited radi-illumination image accumulated from 50 images and each with a 100 ms exposure time by the Dhyana95. The total acquisition time of 50 images is less than 10 s, while the same image effect achieved with a back-illuminated CCD camera is a couple of minutes.

Model	Dhyana95 V2
Sensor model	BSI sCMOS
Shutter type	Rolling
Color/Mono	Mono
Effective area	22.5mm x 22.5mm
Resolution	2048(H) x 2048(V)
Pixel size	11um x 11um
QE	95%@560nm
Full-Well capacity	HDR: 80ke-; STD: 100ke-
Dynamic Range	90dB
Frame rate	24fps@16bit HDR, 48fps@12bit STD
Readout noise	1.6e-(Median)/1.7e-(RMS)
Exposure time	21μs~10s
DSNU	0.2e-
PRNU	0.3%
Cooling Method	Air & Liquid
Cooling temperature	45°C below ambient
Dark current	Air: 0.5e-/pixel/s, Liquid: 0.25e-/pixel/s
Binning	2x2, 4x4
ROI	2048x1024, 2048x512, 1608x1608, 1200x1200, 1024x1024, 512x512, 256x256
TimeStamp	1 μs accuracy
Trigger Mode	Hardware & Software
Output Trigger Signals	Exposure, Global, Readout, High level, Low level
Trigger Interface	SMA
Data Interface	USB3.0/Cameralink
Data Bit Depth	16bit
Optiona Interface	C-mount & F-mount
Power Supply	12V/8A
Power Consumption	60W
Dimensions	C-mount: 100mm x 118mm x 127mm F-mount: 100mm x 118mm x 157mm
Weight	1613g
Software	Mosaic / LabVIEW / Matlab / Micromanager / MetaMorph
SDK	C / C++
Operating System	Windows/Linux
Operating Environment	Temperature 0~40°C / Humidity 10~85%

Dimensions



Part Number for Purchase

	Water cooling (-W)	
	Dhyana 95V2-W-U3	Dhyana 95V2-W-CL
USB3.0 (-U3)	●	
CameraLink (-CL)		●

	Forced air (-F)	
	Dhyana 95V2-F-U3	Dhyana 95V2-F-CL
USB3.0 (-U3)	●	
CameraLink (-CL)		●

Tucsen Photonics Co., Ltd.

Address: 5#, No.2 Yangqi Branch Rd, Gaishan Town, Cangshan Area, Fuzhou, Fujian, PRC, China.

Tel: + 86-591-28055080

Website: www.tucsen.com

Email: support@tucsen.com